

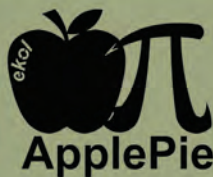

Summer 2023



Introduction

The 'ApplePie' & 'PumpkinPie' range by Ekol.

Whether it be for a boat, yurt, glamping pod, shepherd's hut or just a compact fireplace, The ApplePie / PumpkinPie can be adapted and customised to suit. With its very low distance to combustibles this stove is ideal for small spaces.

With its individual styling and multiple cooking options including stainless cooktop, top baking oven, pan supports to one or both sides as well as griddle plate and pizza shelf inside, the ApplePie / PumpkinPie is the 'Swiss Army Knife' of wood burning stoves.

Amongst an elite handful of small-space stoves fully compliant with DEFRA and Ecodesign 2022 it can be used to burn wood anywhere in the UK.

With full cast iron construction and weighing in heavier than many stoves more than twice its size, it really is built to last.

Primary, Secondary and Tertiary air are intuitively controlled by a single air control and with an extra large window, enthusiastic fire-starters and chefs can easily monitor their creations.



Baked Apple Stack

Technical Specification

- EcoDesign Ready
- 82% Efficient (ApplePie) 78.4% Efficient (PumpkinPie)
- 4 kW Nominal Heat Output (ApplePie)
5kW and 7.4kW Nominal Heat Output (PumpkinPie)
- Heat Output Range 1- 4 kW (ApplePie)
Heat Output Range 2- 8 kW (PumpkinPie)
- 10 Year Warranty
- DEFRA Exempt / Approved for Smoke Control Areas
- Ultra-Clean-Burning
- Superior Air-wash System for Crystal-Clear Views
- Full Cast Iron Construction
- Includes Grate
- Can be used with 4" Top or Vertical Rear Flue Outlet
(5" top or Vertical Rear Outlet PumpkinPie)
- Suitable for use on a 12mm Hearth
- Internal and External Cooking Options
- Optional External Air
- Intuitive Single Air Control
- Includes removable Pizza / Griddle Shelf
- Low Distance to Combustibles

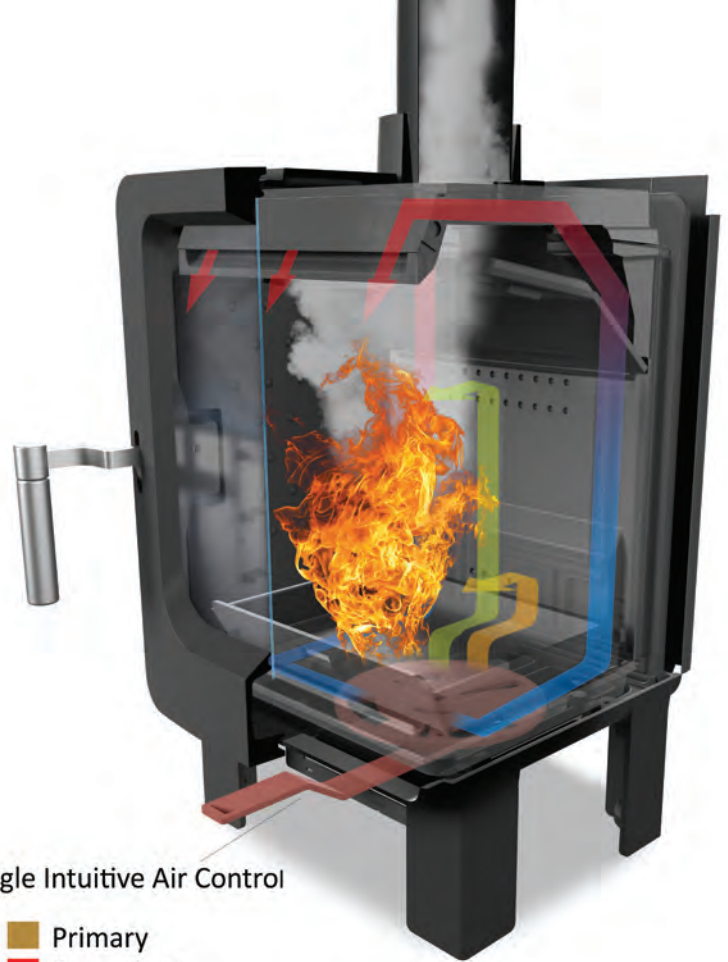

Single Intuitive Air Control

- Primary
- Secondary
- Tertiary



Baked Pumpkin Stack



Inside or outside.

(we recommend shelter from direct rain)

Baked Apple

A cozy indoor scene featuring a wood-burning stove with a fire, a wooden table with a mug, a basket of yarn, and a chair. The stove is white with a black top and a glass door showing a bright fire. The table is made of light-colored wood and holds a brown ceramic mug, a wicker basket filled with colorful yarn and knitting needles, and a spool of white twine. A wooden chair with a curved back is in the foreground. The background is a rustic stone wall.

Cooking, Heating or both.

Versatility as Standard.



Baked Apple Stack



Choose your model

Brushed stainless steel and hardwood handles included with every stove.
Internal (removable) pizza / griddle shelf included with every stove.

Apple Core



Apple Stack



Baked Apple



Baked Apple Stack





PumpkinPie

Choose your model

Brushed stainless steel and hardwood handles included with every stove.

Internal (removable) pizza / griddle shelf included with every stove.

Pumpkin Core



Pumpkin Stack



Baked Pumpkin



Baked Pumpkin Stack



Optional Extras

Available on both ApplePie and PumkinPie

- Pot / Pan Safety Rail
- Top Cooking or Warming Plate
(cooking plate when fitted to core models
Warming plate when fitted to Top Oven)

- Top Oven
- Left Side Plate
- Right Side Plate
- Pedestal / Store
- External Air Inlet
- Vertical Rear Flue Outlet
- Small or Large Enclosures
- Colour Options Available

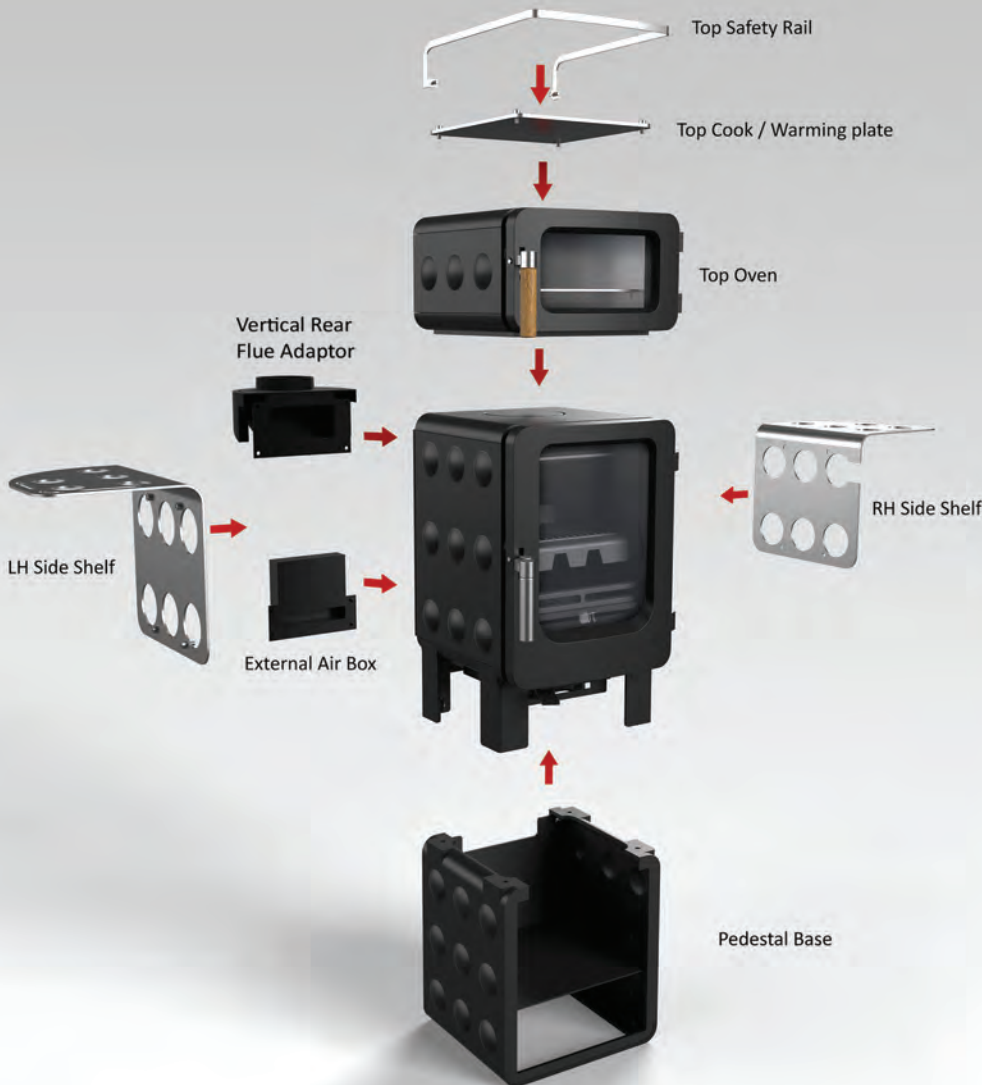

Enclosures

ApplePie Low Enclosure

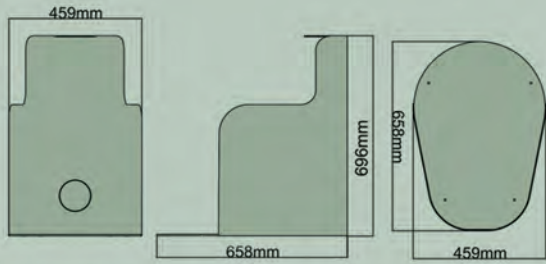

ApplePie Tall Enclosure

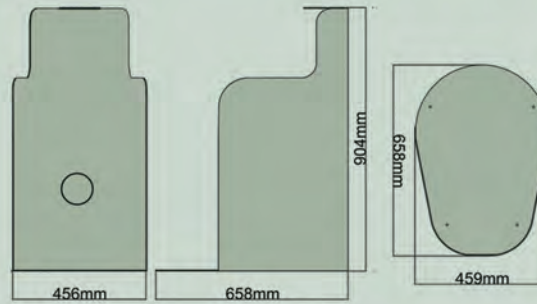

PumpkinPie Low Enclosure

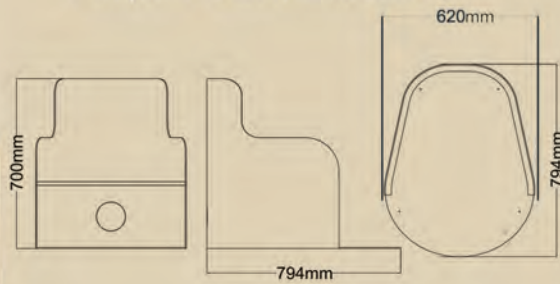

PumpkinPie Tall Enclosure

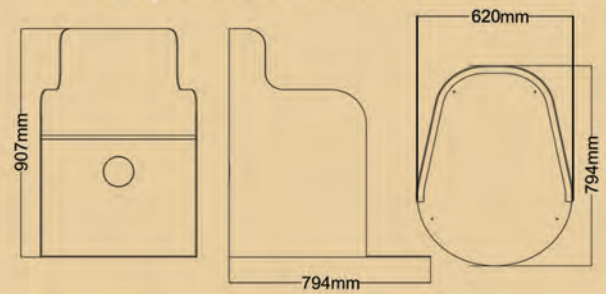

eko/ApplePie

Apple Stack

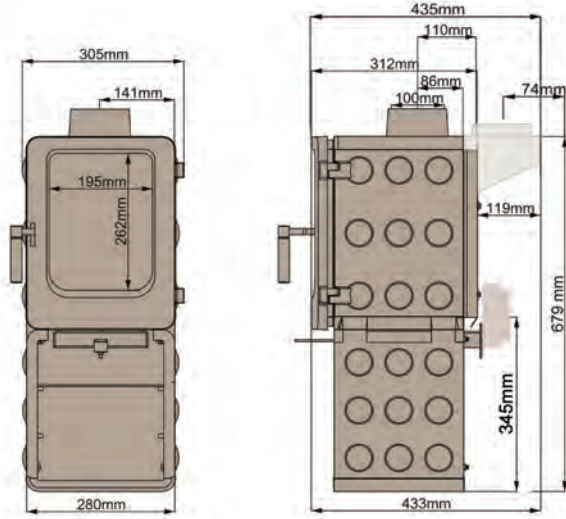

Apple Core

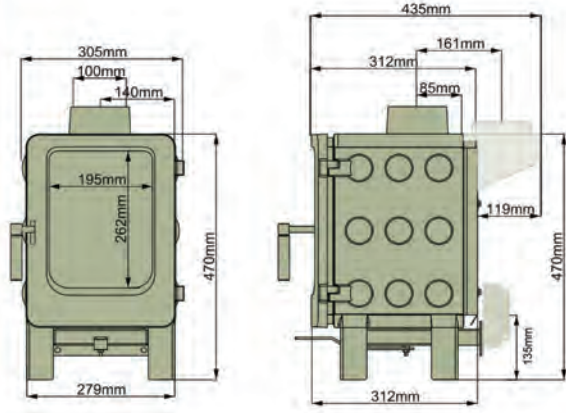

Baked Apple Stack

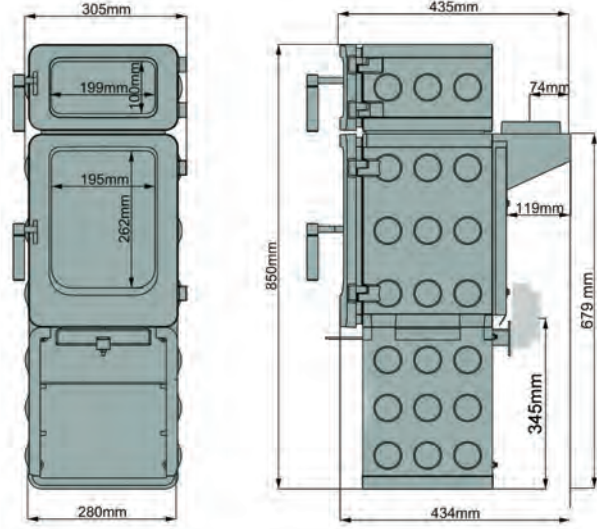

Baked Apple

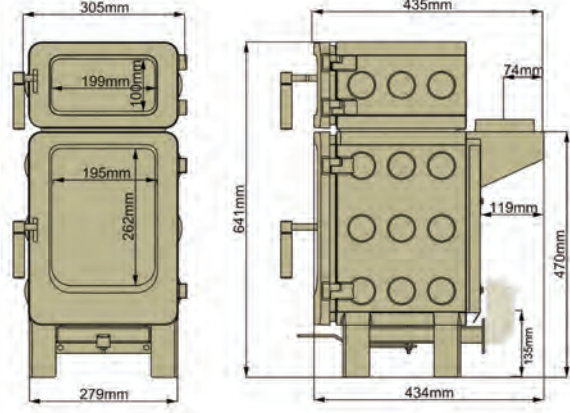

eko/ PumpkinPie

Pumpkin Stack

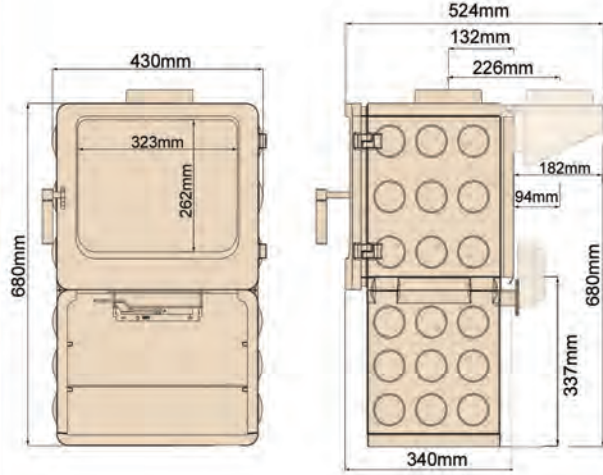

Pumpkin Core

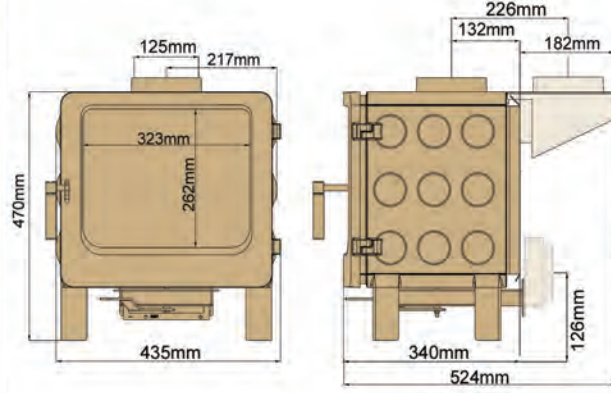

Baked Pumpkin Stack

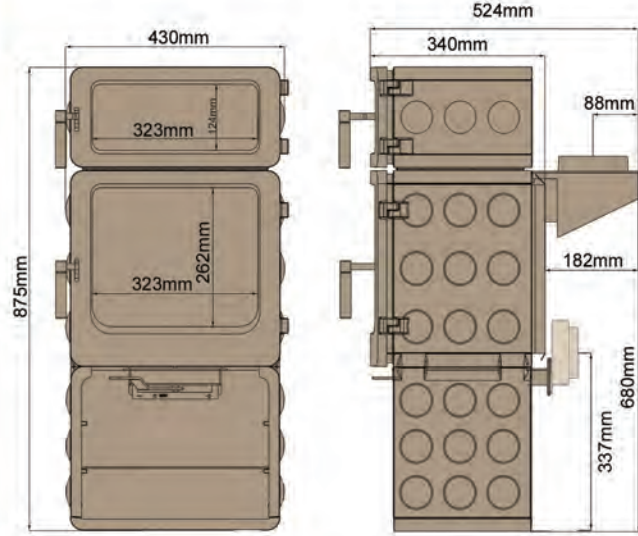

Baked Pumpkin Core

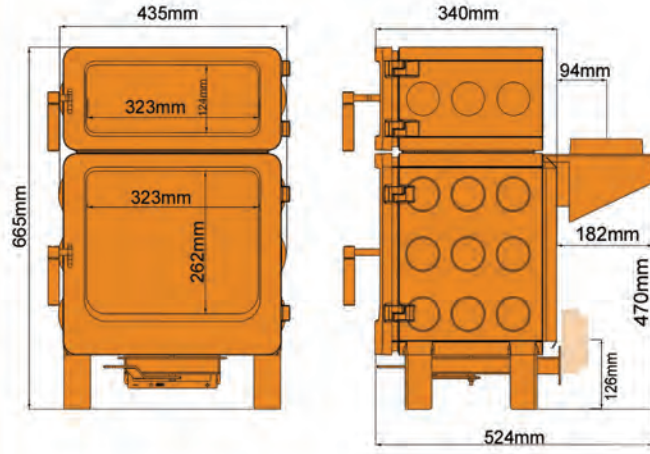

Stove Internals

(included with every stove)



Reversible Pizza Shelf / Griddle Plate



Removable Grate and Log Retainer Bar



Heavy Duty Burn Tray / Ashpan
(Wood can be burnt directly in tray)



Multitool



Optional Body and door colours (actual product colours may vary from colours shown)

- Metallic Black
(standard)
- Charcoal
- Light Grey
- Metallic Blue
- Patriot Blue
- Almond
- Mojave Red
- Apple Green
- Green Illusion
- Burnished
(Door Only)
- copper



Top Oven

(Available for Both ApplePie and PumpkinPie)

- Ideal for cooking, baking and warming food.
- Adjustable shelf height to allow for various size pots and baking trays.
- Reaches temperatures in excess of 200 °C
- Includes both Brushed Stainless Steel and hardwood Handles
- Optional body and door colours available.

'Removable' Large Oven

(Available for ApplePie only)

Optional taller oven available (for the ApplePie stove only)

This handy oven is not only taller than the standard ApplePie oven but removable thanks to its lifting handles. No bolts required to fix in place, this oven locks over the edge of the cookplate below to create a secure fit, making it easier to access the plate below for boiling kettles and stove top cooking if required.

Standard Oven

Removable Large oven

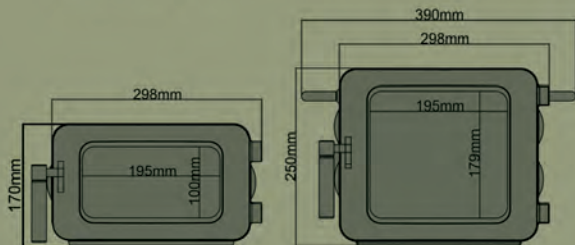

Bake...



Boil & Simmer...

Fry...



Griddle...

ApplePie Distance to Combustibles



SINGLE WALL FLUE
Rear Flue Configuration
Back Wall: 250mm
Side Wall: 350mm

(210 mm from back of stove to wall
when used without Vertical Rear Flue Adaptor)

* Distances from flue to wall need separate consideration
based on local regulations and flue designation



TWIN WALL FLUE
Rear Flue Configuration
Back Wall: 50mm
Side Wall: 300mm

(100 mm from back of stove to wall
when used without Vertical Rear Flue Adaptor)



TWIN WALL FLUE
Corner Configuration
Left Side Wall: 150mm
Right Side Wall: 150mm

(Observe same distances when using
top outlet and twinwall)

Distances can be reduced further with adjacent shielding on the wall. (Contact us for details)

PumpkinPie Distance to Combustibles



**SINGLE WALL FLUE
Rear Flue Configuration**

Back Wall: 350mm
Side Wall: 350mm

(350mm from back of stove to wall
when used without Vertical Rear Flue Adaptor)

* Distances from flue to wall need separate consideration
based on local regulations and flue designation



**TWIN WALL FLUE
Rear Flue Configuration**

Back Wall: 75mm
Side Wall: 350mm

(75mm from back of stove to wall
when used without Vertical Rear Flue Adaptor)



**TWIN WALL FLUE
Corner Configuration**















Left Side Wall: 200mm
Right Side Wall: 200mm

(Observe same distances when using
top outlet and twinwall)

Distances can be reduced further with adjacent shielding on the wall. (Contact us for details)

Configure Your Stove

Step 4- Additional Options

Step 1 Select your Model		Step 2 Select Body colour	Step 3 Select Door colour	 Top Cook Plate	 Pot Safety Rail	 Left Hand Side Shelf	 Right Hand Side Shelf	 External Air Box	 Vertical Rear Flue Outlet	 Stove Enclosure
 Apple Core	 Pumpkin Core									
 Baked Apple	 Baked Pumpkin								already included	
 Apple Stack	 Pumpkin Stack									
 Baked Apple Stack	 Baked Pumpkin Stack								already included	

Colour options (please write your chosen colours in boxes provided above)

Metallic Black

Charcoal

Light Grey

Metallic Blue

Patriot Blue

Almond

Mojave Red

Apple Green

Green Illusion

Copper

Burnished (Door Only)

Additional Notes





Thank you for taking the time to consider an Ekol Stove. We understand that choosing the right stove can be an important decision.

If you would like any guidance at all, please contact either your local Ekol specialist or you are more than welcome to contact us directly for any information or support.

Your new Ekol ApplePie / PumpkinPie will come with 10 years body warranty for peace of mind, and technical support forever should you need it.

The ApplePie range of options will continue to expand - if there is a variation or design option you would like but cannot see in the brochure, you can contact us or take a look at the website for new design options as they emerge.

Visit www.applepiestove.com

For details of your nearest specialist retailer and to see which models they have on display, simply enter your postcode on the website www.ekolstoves.com

Here at Ekol we can be contacted directly by email at sales@defrastoves.com, or by telephone on (UK) +44(0)1929 555211.



www.applepiestove.com www.ekolstoves.com Tel: 01929 555211